

<b>Electrical Characteristics</b>										
Frequency	Hz	50				60				
Voltage (series star)	V	380	400	415	440	415	440	460	480	
Rated power class H	kVA	8	8	8	6,8	9	9,6	9,6	9,6	
	kW	6,4	6,4	6,4	5,4	7,2	7,7	7,7	7,7	
Rated power class F	kVA	7,5	7,5	7,5	6,4	7,5	8	9	9	
	kW	6	6	6	5,1	6	6,4	7,2	7,2	
Regulation with SR7/2		±1,5 % with any power factor and speed variations between -5% +30%								
Insulation class		H								
Execution		Brushless								
Stator winding		12 ends								
Rotor		without damping cage								
Efficiencies class H	4/4	%	83,6	83,7	83,4	83,2	84,7	85,2	85,3	85,4
(see graph. for details)	3/4	%	84,4	84,7	84,6	84,3	85,7	85,9	86,1	86,3
	2/4	%	80,3	80,4	80,4	80,1	81,6	81,7	81,8	81,9
	1/4	%	75,5	75,6	75,4	74,9	76,8	76,6	76,7	77
Reactances (f. l.cl. F)	Xd	%	201,7	182	169,1	127,9	228,3	216,6	198,2	182
	Xd'	%	18,17	16,4	15,24	11,52	20,57	19,52	17,86	16,4
	Xd''	%	13,07	11,8	10,96	8,29	14,80	14,04	12,85	11,8
	Xq	%	66,6	60,1	55,8	42,2	75,4	71,5	65,4	60,1
	Xq'	%	66,6	60,1	55,8	42,2	75,4	71,5	65,4	60,1
	Xq''	%	71,2	64,3	59,7	45,2	80,6	76,5	70,0	64,3
	X <sub>2</sub>	%	17,95	16,2	15,05	11,38	20,32	19,28	17,64	16,2
	X <sub>0</sub>	%	6,32	5,7	5,30	4,00	7,15	6,78	6,21	5,7
Short Circuit Ratio	Kcc		0,66	0,8	0,99	1,61	0,53	0,61	0,66	0,8
Time Constants	Td'	sec.	0,017							
	Td''	sec.	0,011							
	Tdo'	sec.	0,73							
	T <sub>α</sub>	sec.	0,012							
Short Circuit Current Capacity		%	>300				>320			
Excitation at no load	Amp.		0,25	0,29	0,32	0,35	0,2	0,23	0,25	0,27
Excitation at full load	Amp.		0,7	0,8	0,9	1	0,6	0,65	0,7	0,75
Overload (long-term)		%	1 hour in a 6 hours period 110% rated load							
Overload per 20 sec.		%	300							
Stator Winding Resistance (20°C)	Ω		1,272							
Rotor Winding Resistance (20°C)	Ω		7,141							
Exciter Resistance (20 °C)	Ω		Rotor : 1,453				Stator : 15,71			
Heat dissipation at f.l.cl.H	W		1256	1246	1274	1098	1301	1334	1324	1313
Telephone Interference			THF < 2%				TIF < 45			
Radio interference			EN61000-6-3, EN61000-6-1, VDE 0875 K.							
Waveform Distors.(THD) at f. load	LL/LN %		2,8 / 2,4							
Waveform Distors.(THD) at no load	LL/LN %		2,7 / 2,5							
<b>Mechanical characteristics</b>										
Protection			IP 23 (other protection on request)							
DE bearing			6308-2RS							
NDE bearing			6305-2RS							
Weight of wound stator assembly	kg		19,4							
Weight of wound rotor assembly	kg		14,7							
Weight of complete generator	kg		65							
Maximun overspeed	rpm		2250							
Unbalanced magnetic pull at f.l.cl.F	kN/mm		2,8							
Cooling air requirement	m³/min		3,5				4,1			
Inertia Constant (H)	sec.		0,092				0,111			
Noise level at 1m/7m	dB(A)		72 / 58				78 / 60			

**50 Hz**

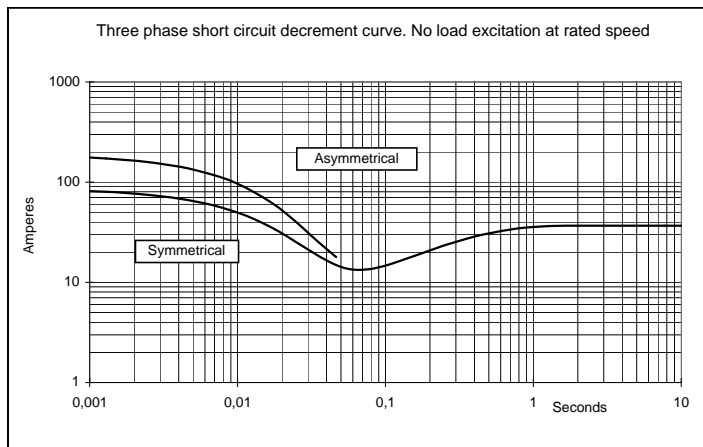

**60 Hz**

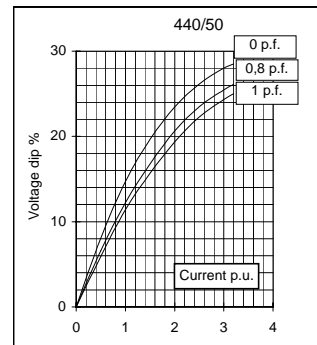
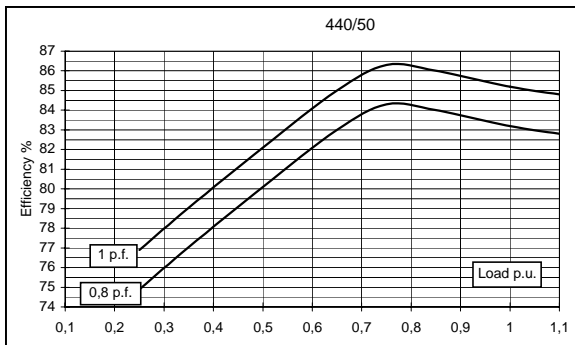
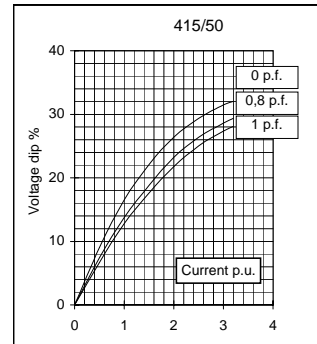
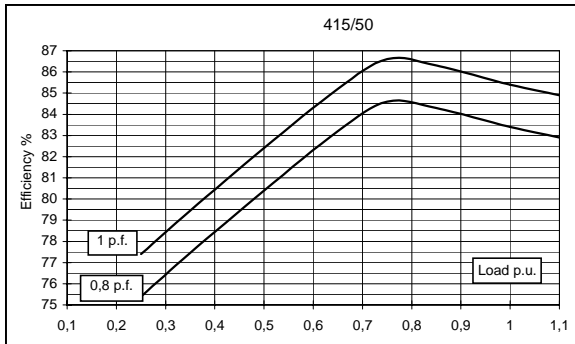
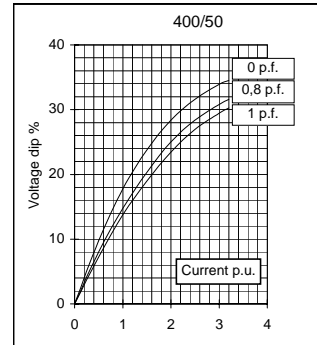
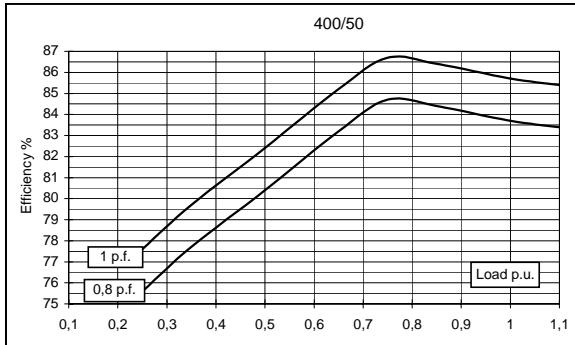
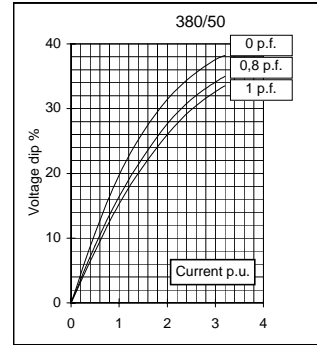
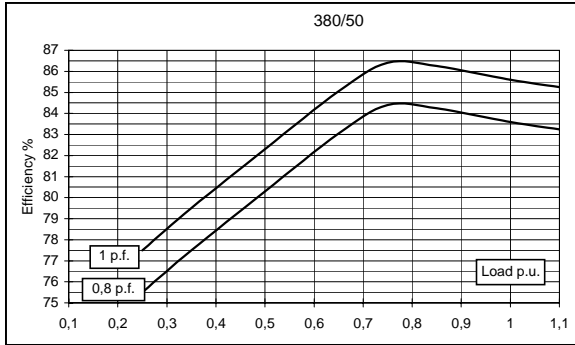
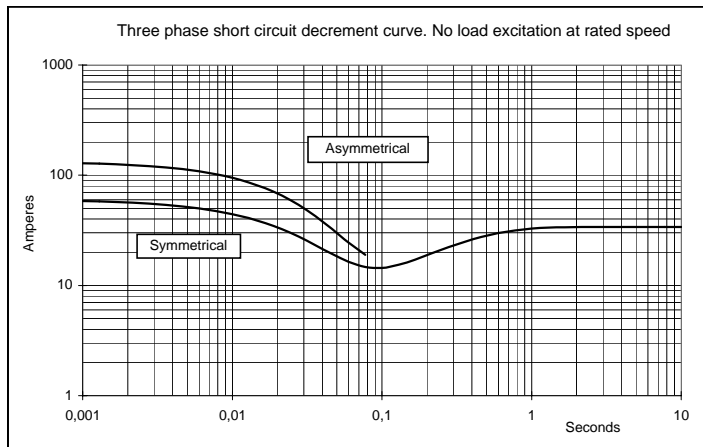
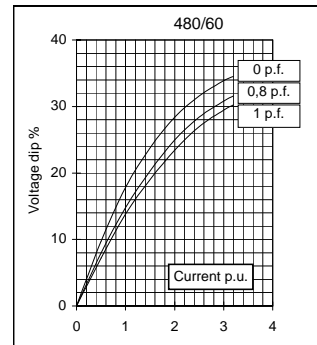
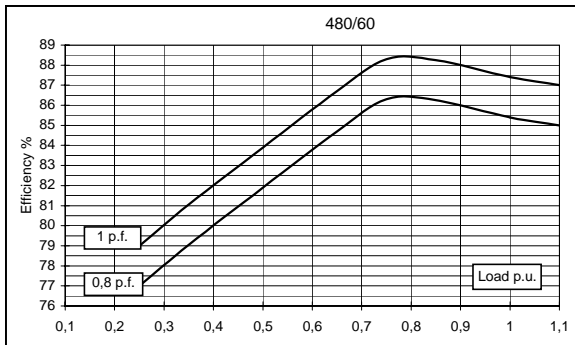
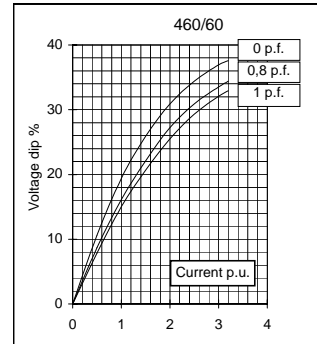
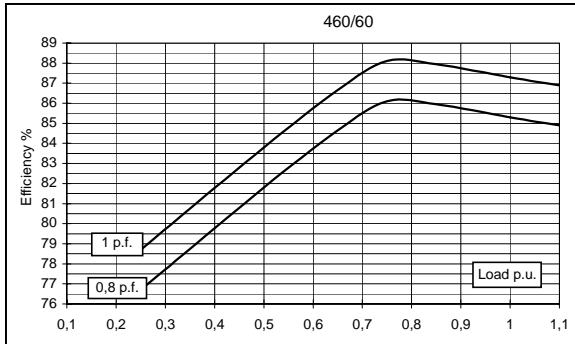
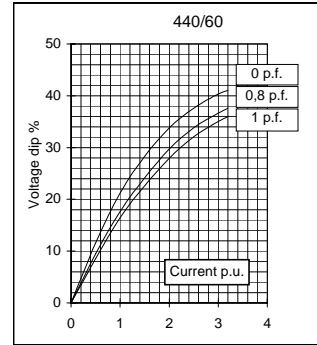
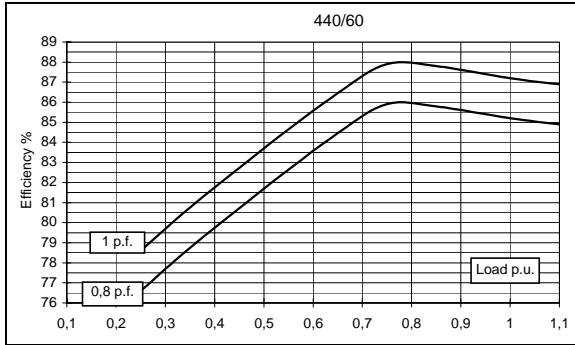
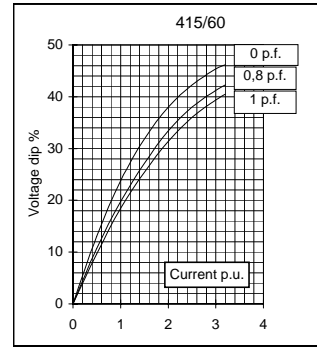
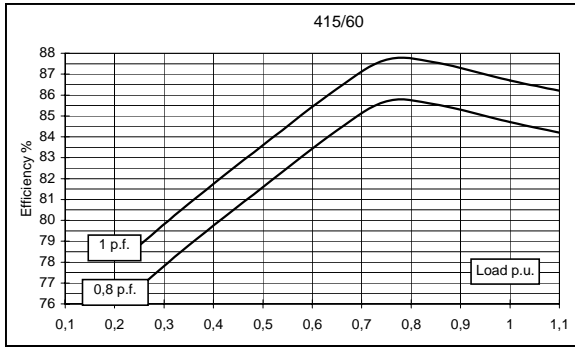

## TWO BEARING MOMENTS OF INERTIA

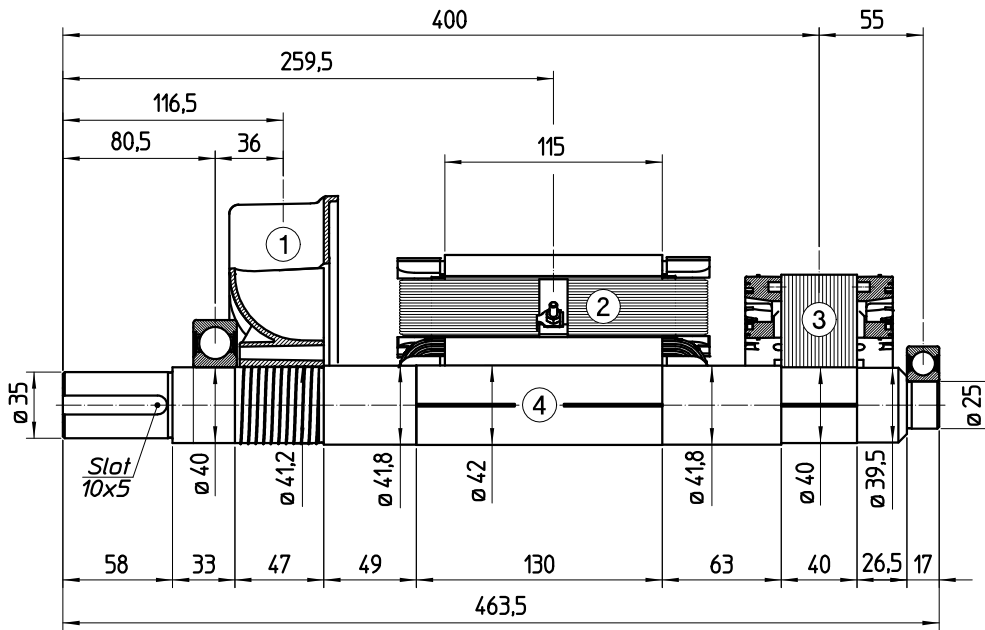

POS.	COMPONENT	WEIGHT (kg)	J (kgm <sup>2</sup> )
1	FAN	0,4	0,00206
2	MAIN ROTOR	14,7	0,04548
3	EX. ROTOR	4,2	0,01086
4	SHAFT	4,5	0,00093
TOTAL		23,8	0,05933

## TWO BEARING DIMENSIONS

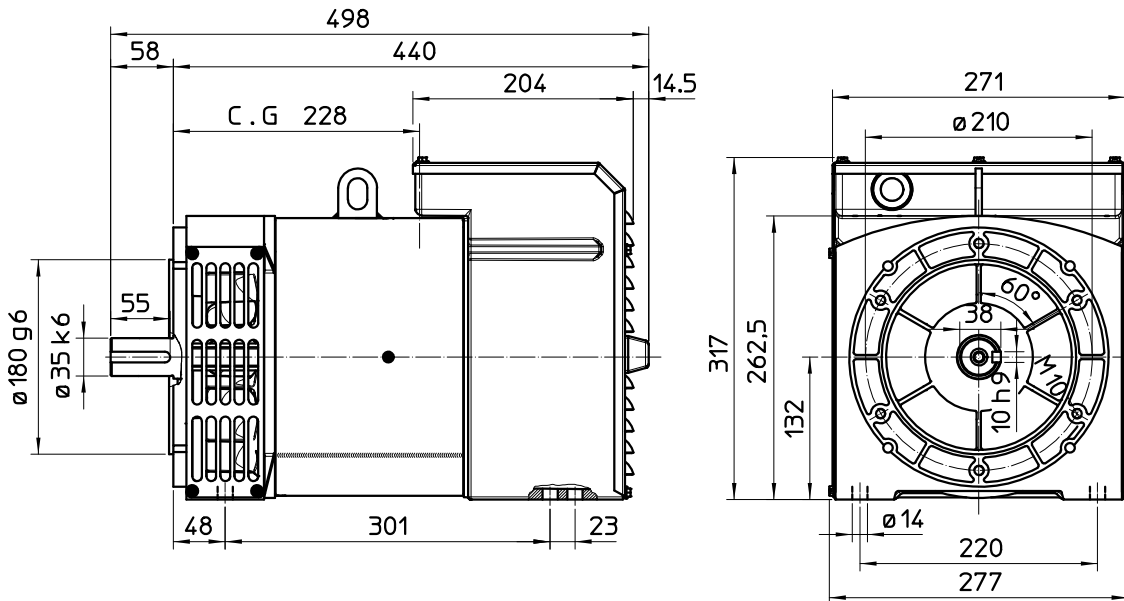

C.G.= GRAVITY CENTER

### SINGLE BEARING MOMENTS OF INERTIA

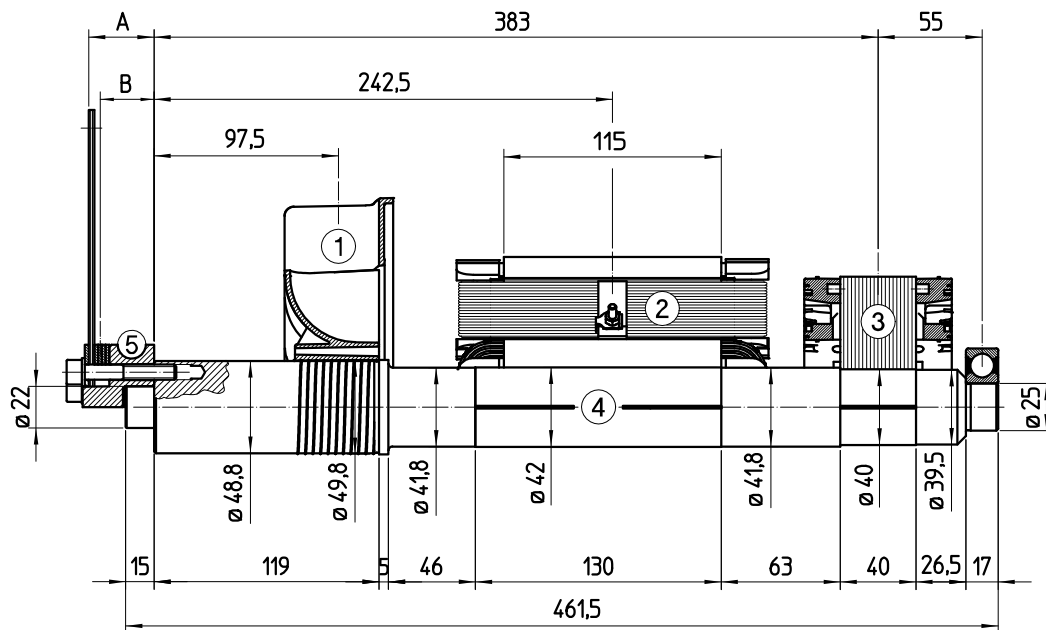

POS.	COMPONENT	WEIGHT (kg)	J (kgm <sup>2</sup> )
1	FAN	0,4	0,00206
2	MAIN ROTOR	14,7	0,04548
3	EX. ROTOR	4,2	0,01086
4	SHAFT	5,1	0,00123
TOTAL		24,4	0,05963

SAE N°	5		SHAFTS COUPLING FLEX PLATE	
	A	B	WEIGHT kg	J kgm <sup>2</sup>
6 1/2	3	1,5	1,00	0,00495
7 1/2	3	1,5	1,20	0,00769
8	34,6	29,5	1,75	0,01114
10	26,6	23,5	2,14	0,02220
11 1/2	13	11	2,60	0,03524

### SINGLE BEARING DIMENSIONS

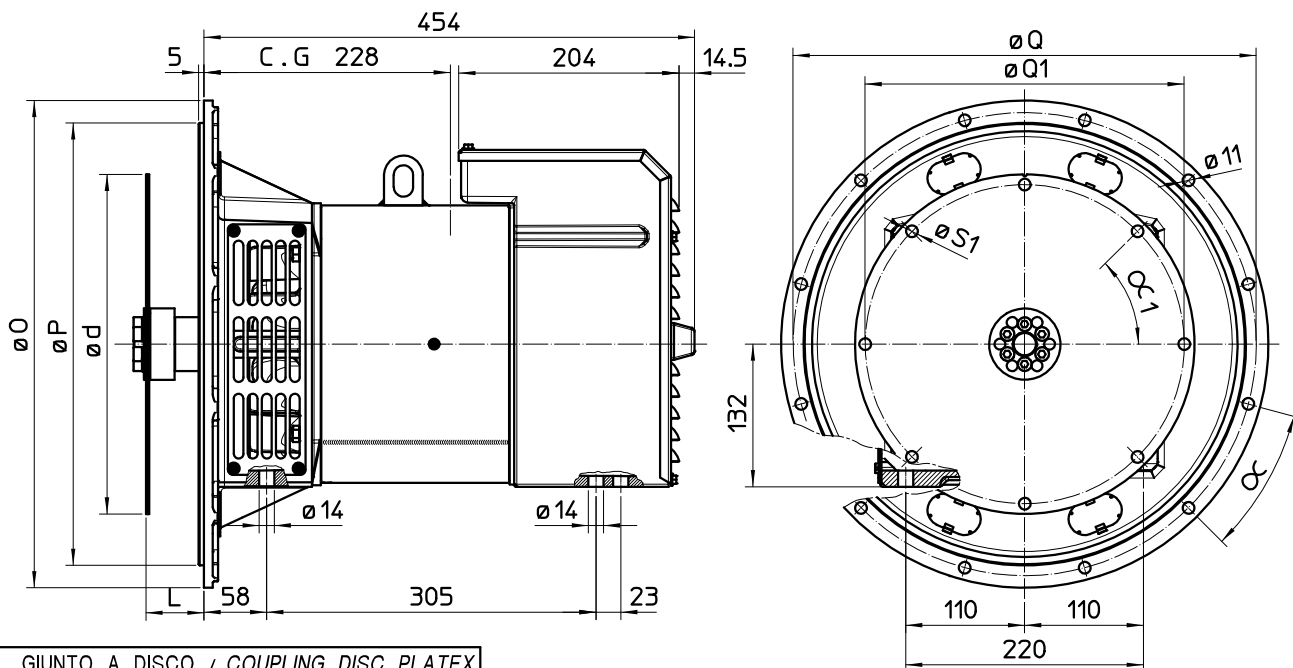

GIUNTO A DISCO / COUPLING DISC PLATEX						
SAE	L	d	Q1	Fori N° Holes N°	S1	α <sub>1</sub>
6 ‡	30,2	215,9	200	6	9	60°
7 ‡	30,2	241,3	222,25	8	9	45°
8	62	263,52	244,47	6	11	60°
10	53,8	314,52	295,27	8	11	45°
11 ‡	39,6	352,42	333,37	8	11	45°

FLANGIE / FLANGE						
SAE	O	P	Q	Fori N° Holes N°	α	
6	308	266,7	285,75	8	22°30'	
5	356	314,3	333,4	8	22°30'	
4	403	362	381	12	15°	
3	451	409,6	428,6	12	15°	

C.G.= GRAVITY CENTER