



**GENERATOR TYPE ECP 28-M/4**

Document : **DS205A/1**  
 issue 000 date 22/03/2012

<b>Electrical Characteristics</b>										
Frequency	Hz	50				60				
Voltage (series star)	V	380	400	415	440	415	440	460	480	
Rated power class H	kVA	20	20	20	18	21	23	24	24	
	kW	16	16	16	14,4	16,8	18,4	19,2	19,2	
Rated power class F	kVA	18,5	18,5	18,5	17	19	20	22	22	
	kW	14,8	14,8	14,8	13,6	15,2	16	17,6	17,6	
Regulation with	DSR	±1 % with any power factor and speed variations between -5% +30%								
Insulation class		H								
Execution		Brushless								
Stator winding		12 ends								
Rotor		without damping cage								
Efficiencies class H	4/4	%	87,3	87,4	87,1	86,9	88,8	89,3	89,4	89,5
(see graph. for details)	3/4	%	87,5	87,8	87,5	87,4	88,9	89,1	89,3	89,5
	2/4	%	85,5	85,6	85,6	85,5	87,2	87,3	87,4	87,5
	1/4	%	83,1	83	82,8	82,3	85,1	85,1	85,1	85
Reactances (f. l.cl. F)	Xd	%	199,4	180	167,2	133,9	210,7	205,3	196,0	180
	Xd'	%	18,61	16,8	15,61	12,50	19,67	19,16	18,29	16,8
	Xd''	%	10,64	9,6	8,92	7,14	11,24	10,95	10,45	9,6
	Xq	%	86,4	78	72,5	58,0	91,3	89,0	84,9	78
	Xq'	%	86,4	78	72,5	58,0	91,3	89,0	84,9	78
	Xq''	%	24,4	22	20,4	16,4	25,8	25,1	24,0	22
	X <sub>2</sub>	%	15,96	14,4	13,38	10,71	16,86	16,42	15,68	14,4
	X <sub>0</sub>	%	3,66	3,3	3,07	2,45	3,86	3,76	3,59	3,3
Short Circuit Ratio	Kcc		0,53	0,62	0,87	1,45	0,41	0,48	0,53	0,62
Time Constants	Td'	sec.	0,044							
	Td''	sec.	0,014							
	Tdo'	sec.	0,85							
	Tα	sec.	0,012							
Short Circuit Current Capacity		%	>300				>320			
Excitation at no load	Amp.		0,4	0,5	0,6	0,8	0,3	0,35	0,4	0,5
Excitation at full load	Amp.		1,4	1,5	1,7	1,9	1,2	1,3	1,4	1,5
Overload (long-term)	%	1 hour in a 6 hours period 110% rated load								
Overload per 20 sec.	%	300								
Stator Winding Resistance (20 °C)	Ω	0,198								
Rotor Winding Resistance (20 °C)	Ω	1,396								
Exciter Resistance (20 °C)	Ω	Rotor : 0,417				Stator : 10,60				
Heat dissipation at f.l.cl H	W	2328	2307	2370	2171	2119	2205	2277	2253	
Telephone Interference		THF < 2%				TIF < 45				
Radio interference		EN61000-6-3 EN61000-6-1. For others standards apply to factory								
Waveform Distors.(THD) at f. load	LL/LN %	2 / 2								
Waveform Distors.(THD) at no load	LL/LN %	3,6 / 3,5								
<b>Mechanical characteristics</b>										
Protection		IP 23 (other protection on request)								
DE bearing		6309-2RS								
NDE bearing		6207-2RS								
Weight of wound stator assembly	kg	41								
Weight of wound rotor assembly	kg	22,2								
Weight of complete generator	kg	118								
Maximun overspeed	rpm	2250								
Unbalanced magnetic pull at f.l.cl.F	kN/mm	3,8								
Cooling air requirement	m³/min	5,3				5,8				
Inertia Constant (H)	sec.	0,073				0,088				
Noise level at 1m/7m	dB(A)	68 / 57				71 / 61				

All technical data are to be considered as a reference and they can be modified without any notice.  
 This document is a propriety of Mecc Alte S.p.a..All rights reserved.

**50 Hz**

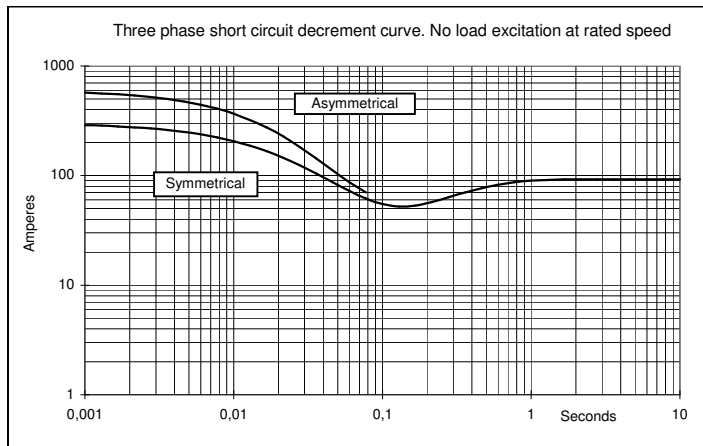
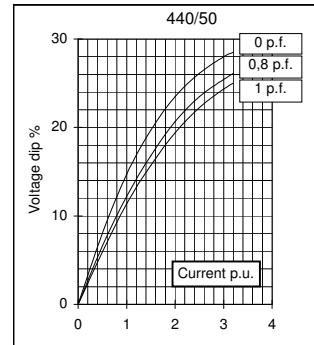
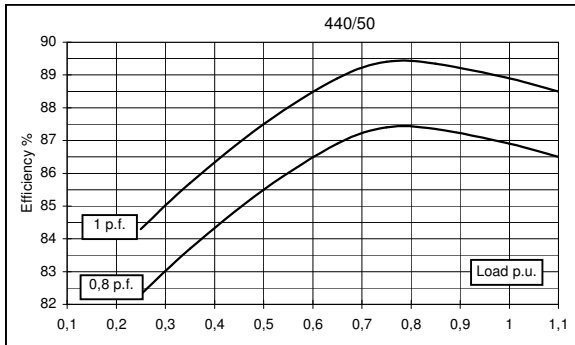
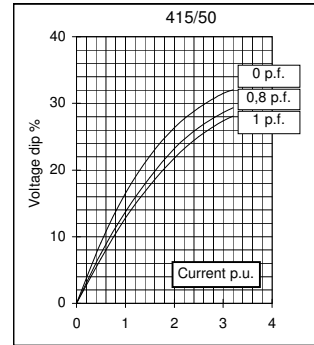
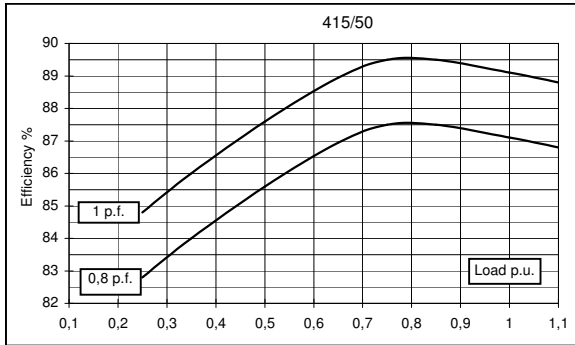
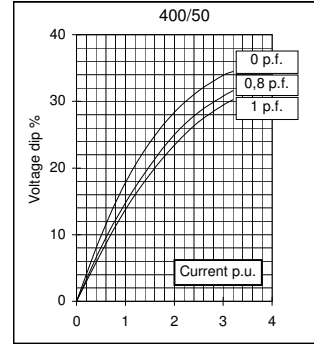
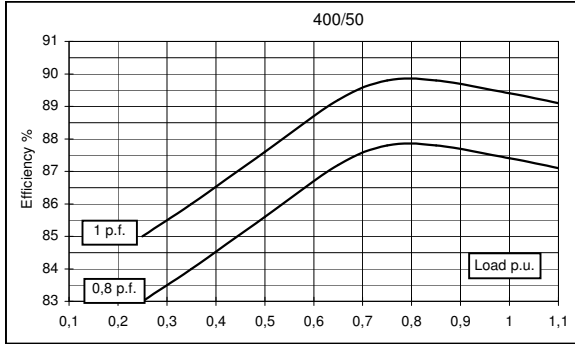
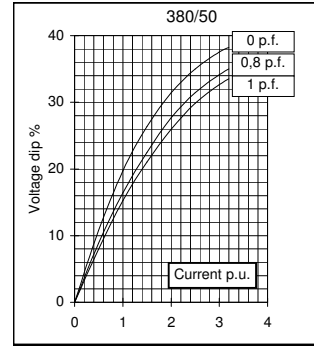
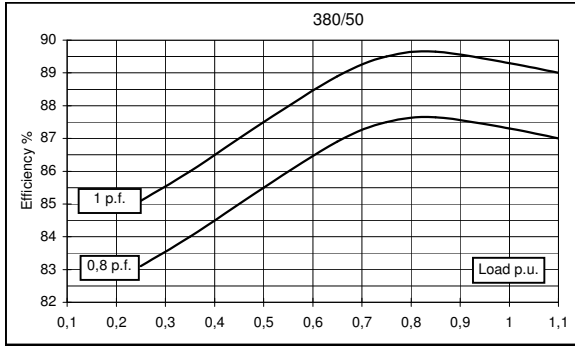

**60 Hz**

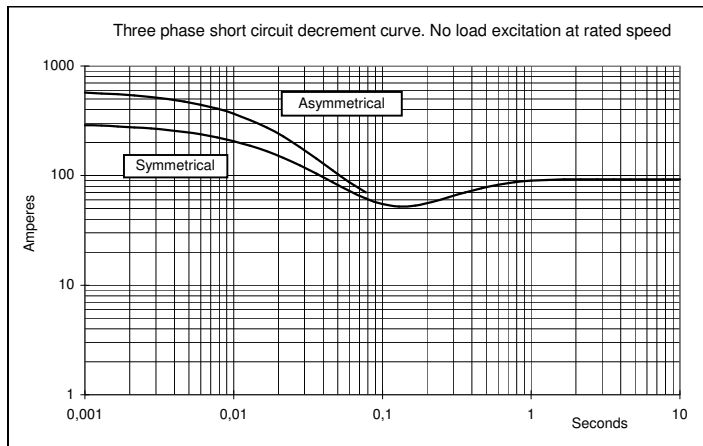
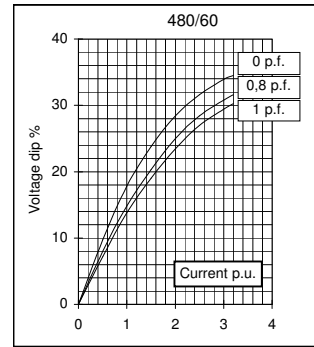
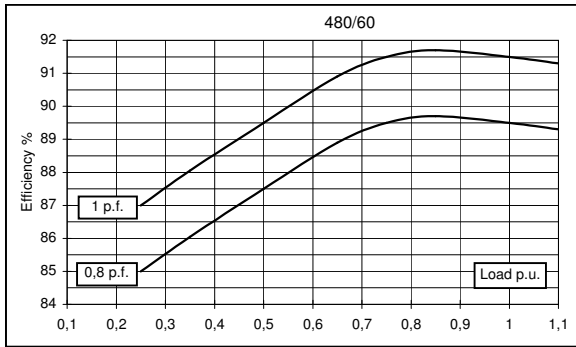
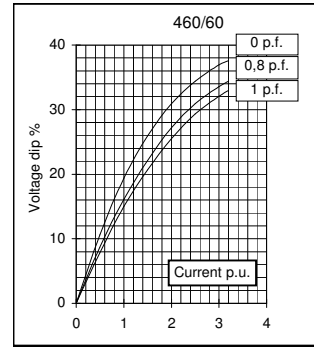
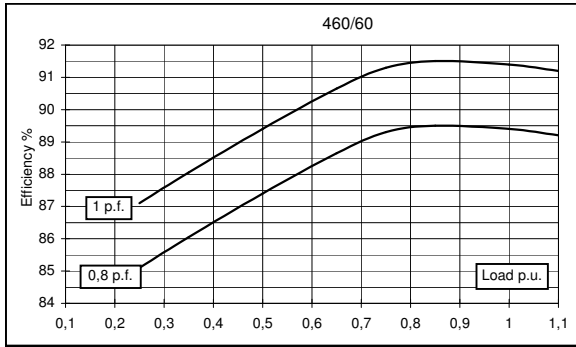
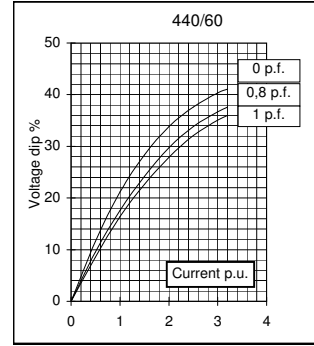
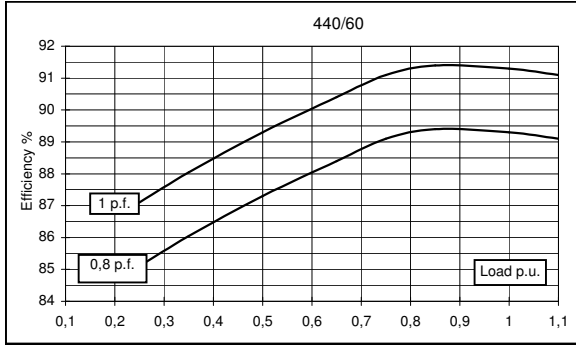
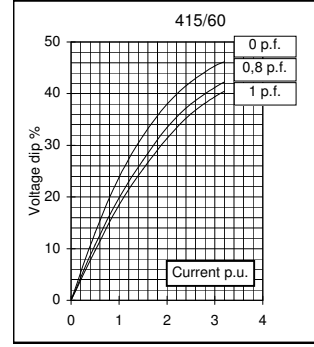
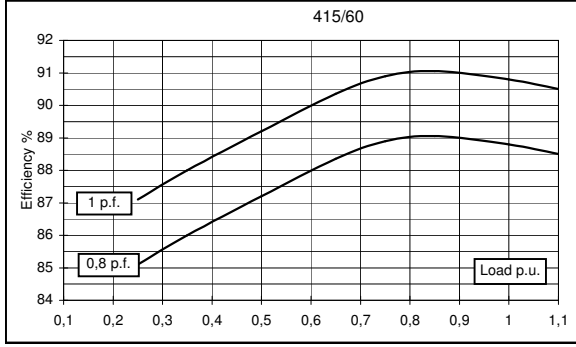

## TWO BEARING MOMENTS OF INERTIA

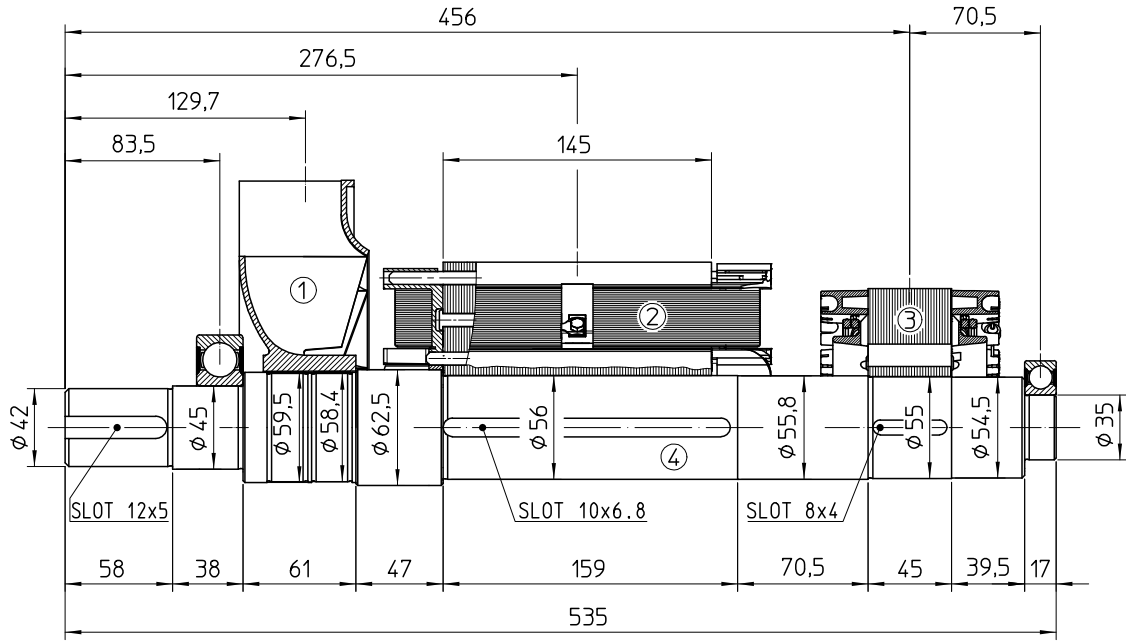

POS.	COMPONENT	WEIGHT (kg)	J (kgm <sup>2</sup> )
1	FAN	1.2	0.0087
2	MAIN ROTOR	22.2	0.0887
3	EX. ROTOR	5.5	0.0172
4	SHAFT	9.4	0.0036
TOTAL		38.3	0.1182

## TWO BEARING DIMENSIONS

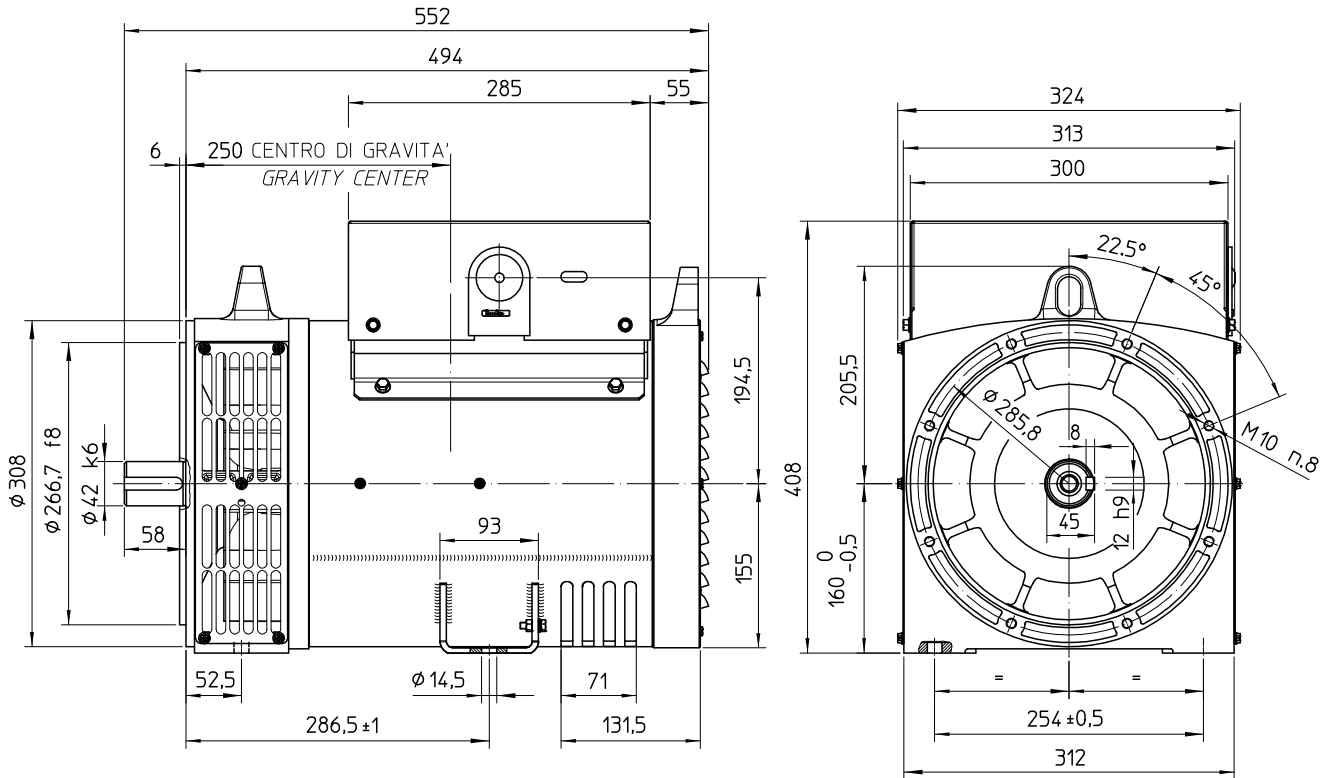

C.G.= GRAVITY CENTER

### SINGLE BEARING MOMENTS OF INERTIA

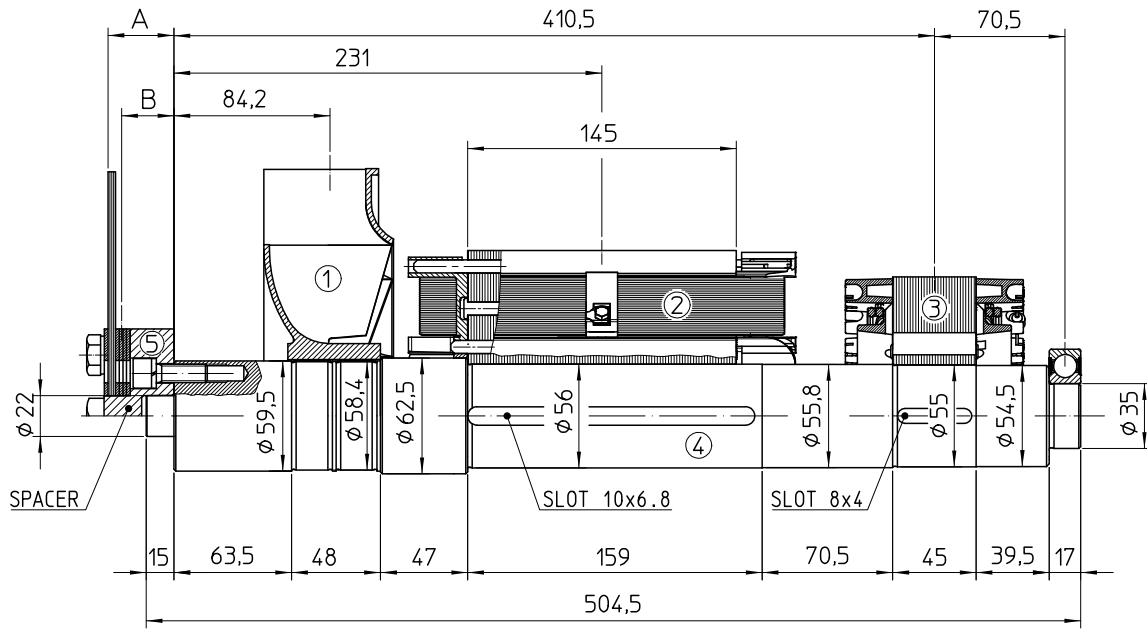

POS.	COMPONENT	WEIGHT (kg)	J (kgm <sup>2</sup> )
1	FAN	1.2	0.0087
2	MAIN ROTOR	22.2	0.0887
3	EX. ROTOR	5.5	0.0172
4	SHAFT	9.4	0.0038
TOTAL		38.3	0.1184

SAE N°	SHAFTS COUPLING FLEX PLATE		WEIGHT kg	J kgm <sup>2</sup>
	A	B		
5				
6 1/2	4	2	1.08	0.0065
7 1/2	4	2	1.35	0.0101
8	35.6	28.3	2.84	0.0158
10	27.6	22.9	3.25	0.0303
11 1/2	14	11.2	3.6	0.0471

### SINGLE BEARING DIMENSIONS

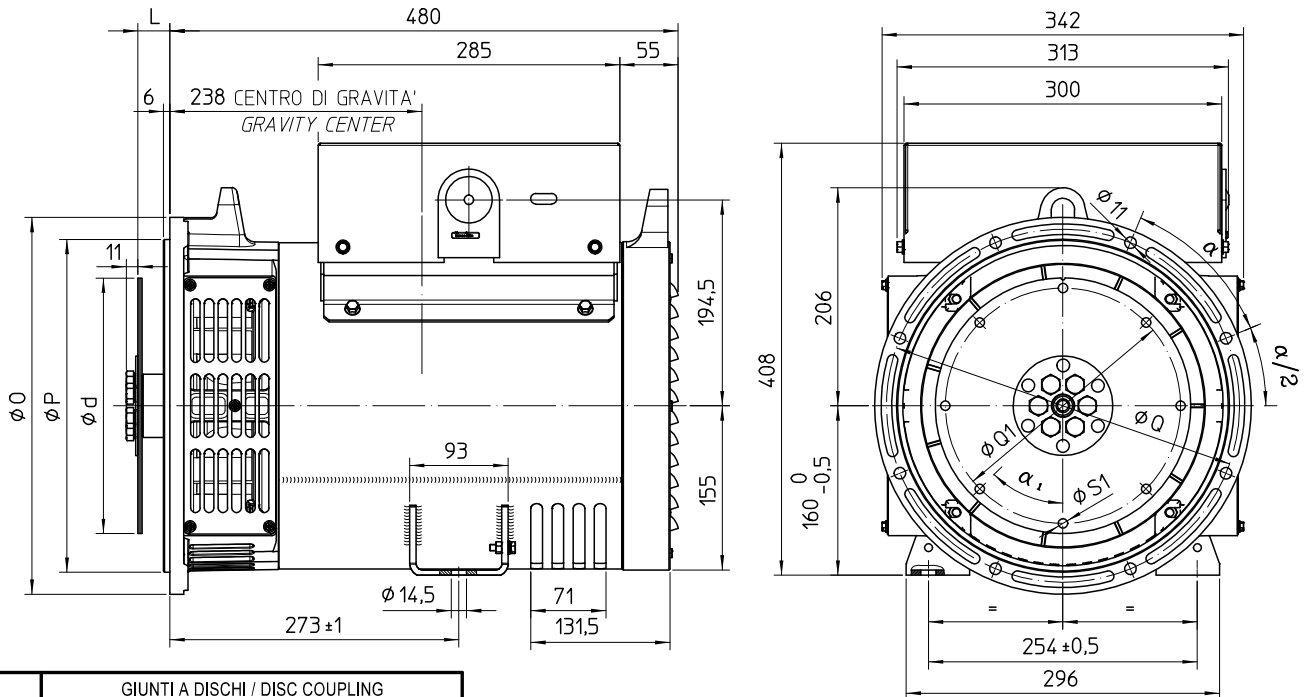

SAE N.	GIUNTI A DISCHI / DISC COUPLING DISCQUE DE MONOPALIER / SCHEIBENKUPPLUNG				
	d	L	Q1	S1	α <sub>i</sub>
6 1/2	215.9	30.2	200	9	60°
7 1/2	241.3	30.2	222.25	9	45°
8	263.52	62	244.47	11	60°
10	314.32	53.8	295.27	11	45°
11 1/2	352.42	39.6	333.37	11	45°

SAE N.	FLANGIA / FLANGE BRIDE / FLANSCH			
	O	P	Q	α
5	356	314.3	333.4	45°
4	403	362	381	30°
3	451	409.6	428.6	30°
2	490	447.7	466.7	30°

C.G.= GRAVITY CENTER